

Aleabrax Systems

SERVICE MANUAL

Structure of this Service Manual

The first section shows the various Flow Charts that detail the errors that might occur onto our P.C.B.'s .

P.C.B. for condensing boilers and tankless water heaters:

- 40-00077 (MIAH4xx) Boilers Combi-Tech / Dual-Tech
- 40-00279 (MIAH4xx) Water heaters Flow-Tech

Additional P.C.B.'s:

- 40-00318 (KMAH2xx) Interface Modbus > cascades of condensing boilers
- 40-00325 (KMAH3xx) Interface Modbus > cascades of condensing tankless water heaters

Accessories:

- 40-00017 (ROAB) Remote Controller Opentherm Easy Remote

The additional P.C.B.'s and/or accessories, if connected as Opentherm/Modbus onto the main boards, might lead to errors that are displayed onto the main board itself.

E01 – FLAME ERROR

Does the flame ignite?

YES

The flame stays alit for 10 seconds and then it shuts off: there is a problem onto the detection of the flame.

NO

There is a problem as for the ignition of the burner: are the sparks there?

NO

YES

NOTE: Check the ignition rods: the sparks are to stay throughout the whole network and the distance between the electrodes has to be between 3 and 5 mm.

If the ignition transformer is not correctly fed, check the main P.C.B. and the cable.

Is the electrical supply ok?
- Check if neutral and ground are not reversed;
- Check if the tension between the two is less than 3 v.;
- Check if the unit is correctly grounded.

Check the static and dynamic pressures of the installation, as per **Procedure 1**. Is the gas supply available?

NO

Check the installation and the gas supply

YES

NOTE:
- If the dynamic pressure is low: check the installation and the gas supply.
- If the static pressure is high (> 60 mBar): the gas valve seizes-up.

Is the detection of the ionization current ok?
- Check if the ionization electrode is intact, the metal is steady onto the ceramic, and there is finally continuity from the beginning of the electrode thru to the end of the cable;
- The ionization current must be at least of 5 μ Ampere (as per **Procedure 4**)

The pressure is good also during the sparks: Does the burner get the gas? Refer to **Procedure 2**.

NO

If there is no tension, the issue is about the cable or the main P.C.B. Refer to **Procedure 3** to figure out if the gas valve coils are broken off. If the gas valve is fed and the coils are good, open the adjusting screws and try again **Procedure 2** to figure out if the gas valve is mechanically broken. If eventually the gas goes thru follow **Procedure 7**.

If all the above checks are positive, replace the main P.C.B.

YES

The flame does not alit, or it turns off just after the ignition.

The gas mixture is not good, refer to **Procedure 7** to be able to ignite the unit, then adjust the CO₂.

E02 – INTERVENTION OF THE SAFETY THERMOSTAT (95°C. BOILER, 75° C. WATER HEATER)

Do we have actually an over-temperature?

YES

Does the circulating pump run ?

NO

Is the pump fed? Refer to Procedure 8

YES

Replace the circulating pump

NO

Is the wiring loom intact? Refer to Procedure 5

NO

Replace the wirings

YES

Replace the main P.C.B.

YES

Does the unit modulate correctly?

YES

Check if the installation is air and debris freed.

NO

Is the sensor out of range? Refer to Procedure 6

NO

Replace the main P.C.B.

YES

Replace the sensor

NO

Is there continuity throughout the inlet thermostat? Refer to Procedure 5

NO

Replace the thermostat

YES

Is there continuity onto the wiring loom?

NO

Replace the wirings

YES

Replace the P.C.B.

E03 – INTERVENTION OF THE THERMOFUSE

The thermofuse is a closed/open contact and it can be monitored thru **Procedure 5**.
Is the thermofuse interrupted?

YES

Replace the thermofuse

NOTE

The thermofuse opens at a temperature near the 102 ± 2 °C. When this occurs, it has to be replaced. It is vital to understand why it opened: it is very unlikely it opens on its own.

NO

Is there continuity onto the wirings? Refer to **Procedure 5**

NO

Replace the wirings

YES

Replace the main P.C.B.

Check if the circulating pump is running

Check the smokes temperature

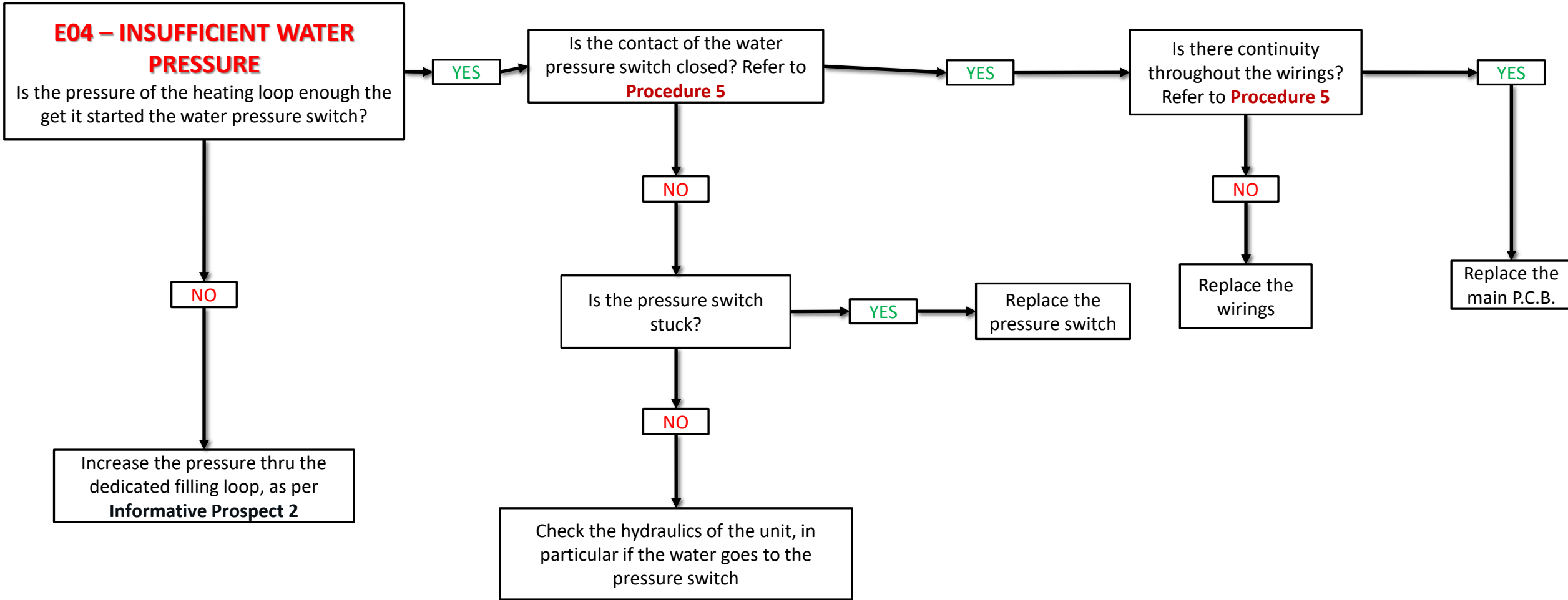

Note

When the E04 error is fixed, the F33 fonction activates the flush of the air : it is highly recommended not to deactivate it, as this might lead to boilings and internal strains within the units.

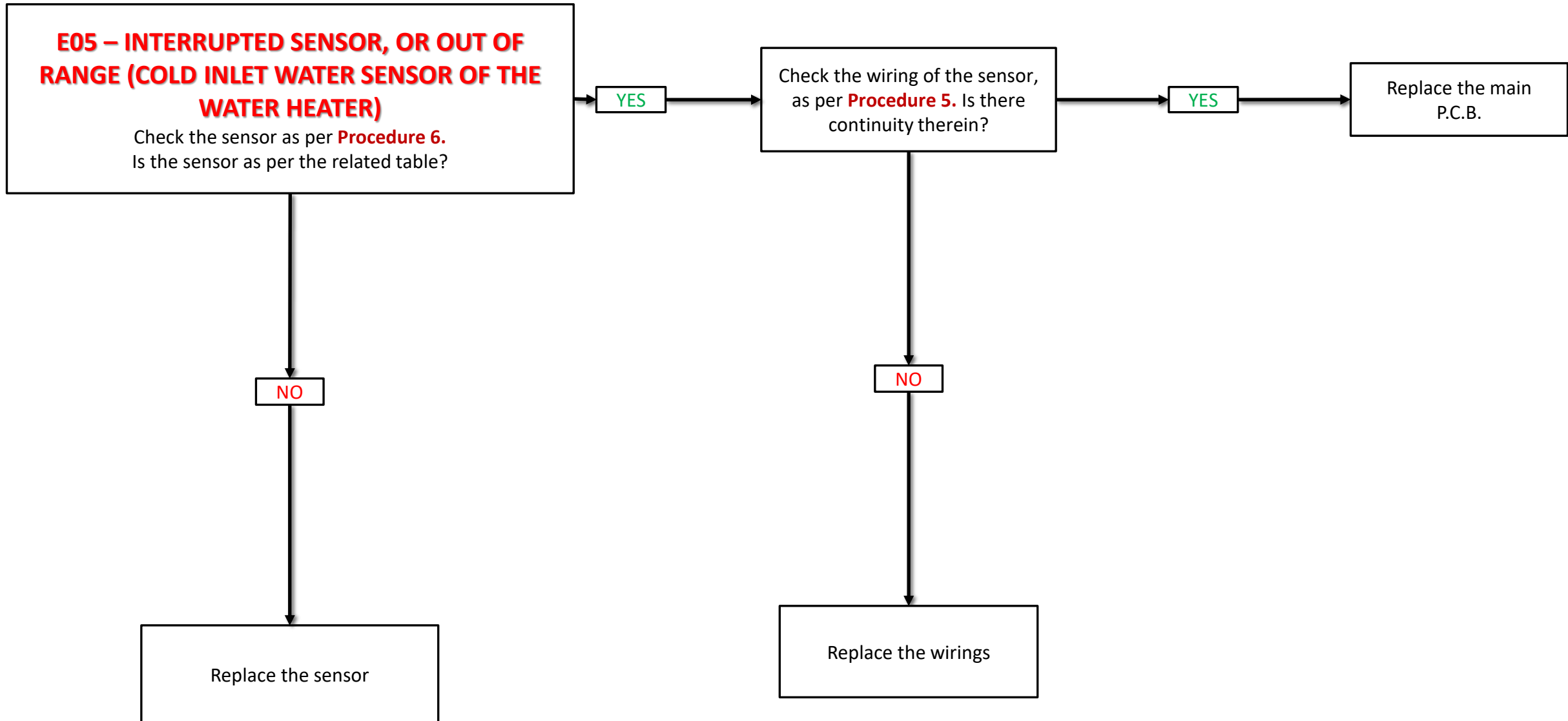

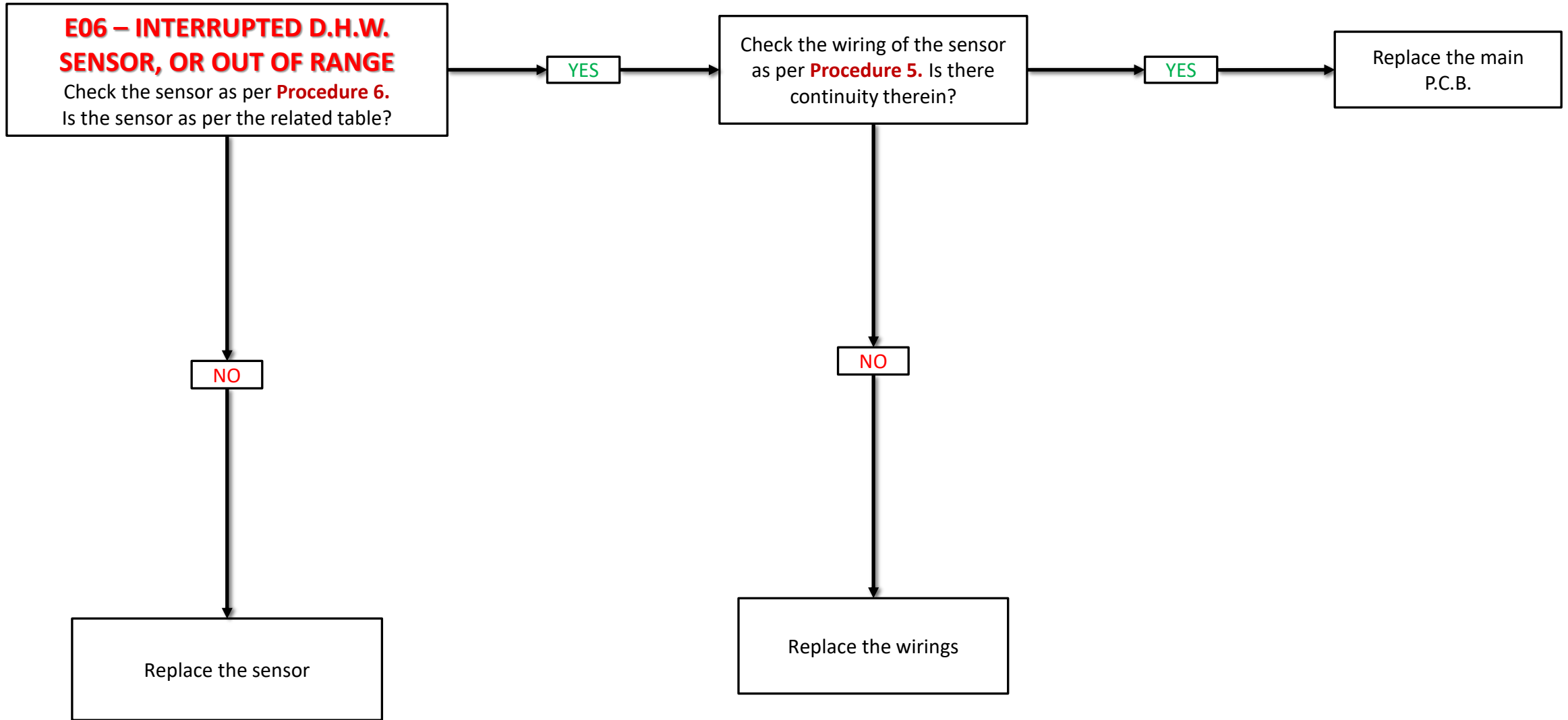

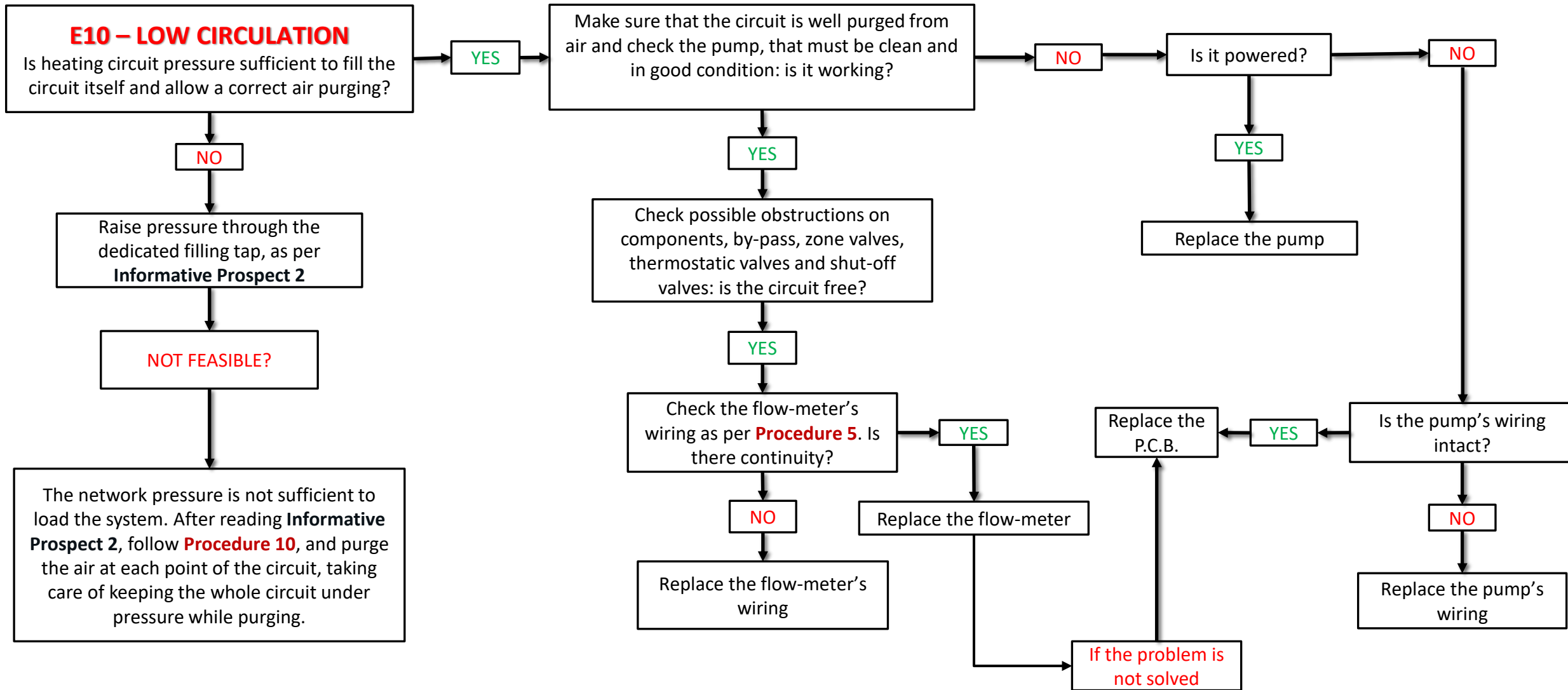

Note

In case the problem has not been solved after completing all checks, carry out a thorough inspection of the hydraulic system and check the pressure losses. Check that the hydraulic circuit and the pump have been correctly sized. Also check that the minimum flow rate set is not higher than the minimum flow rate in the smallest part of the system.

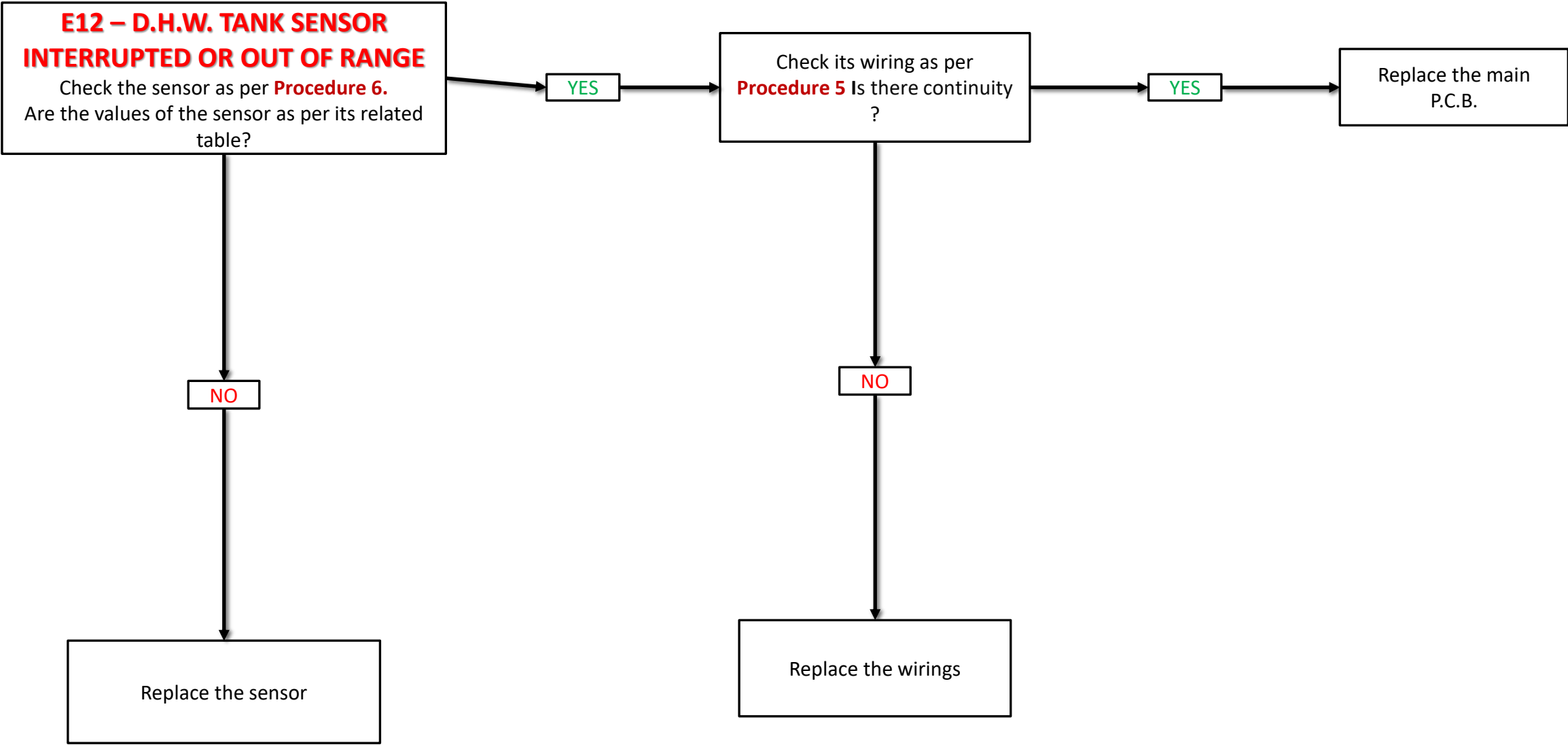

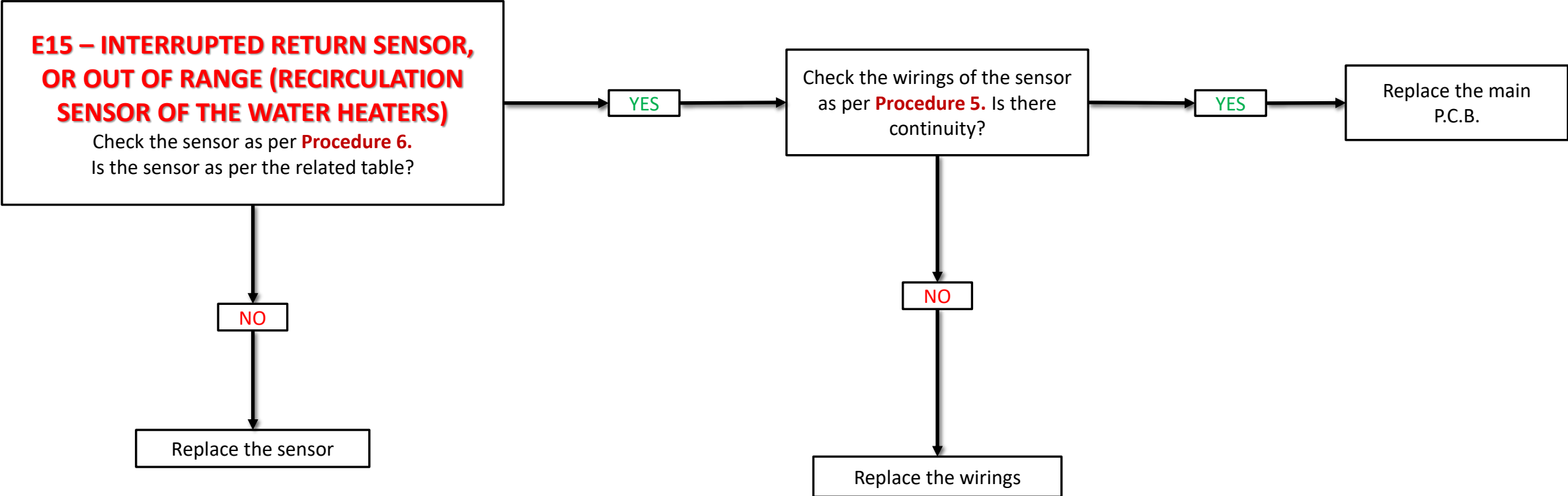

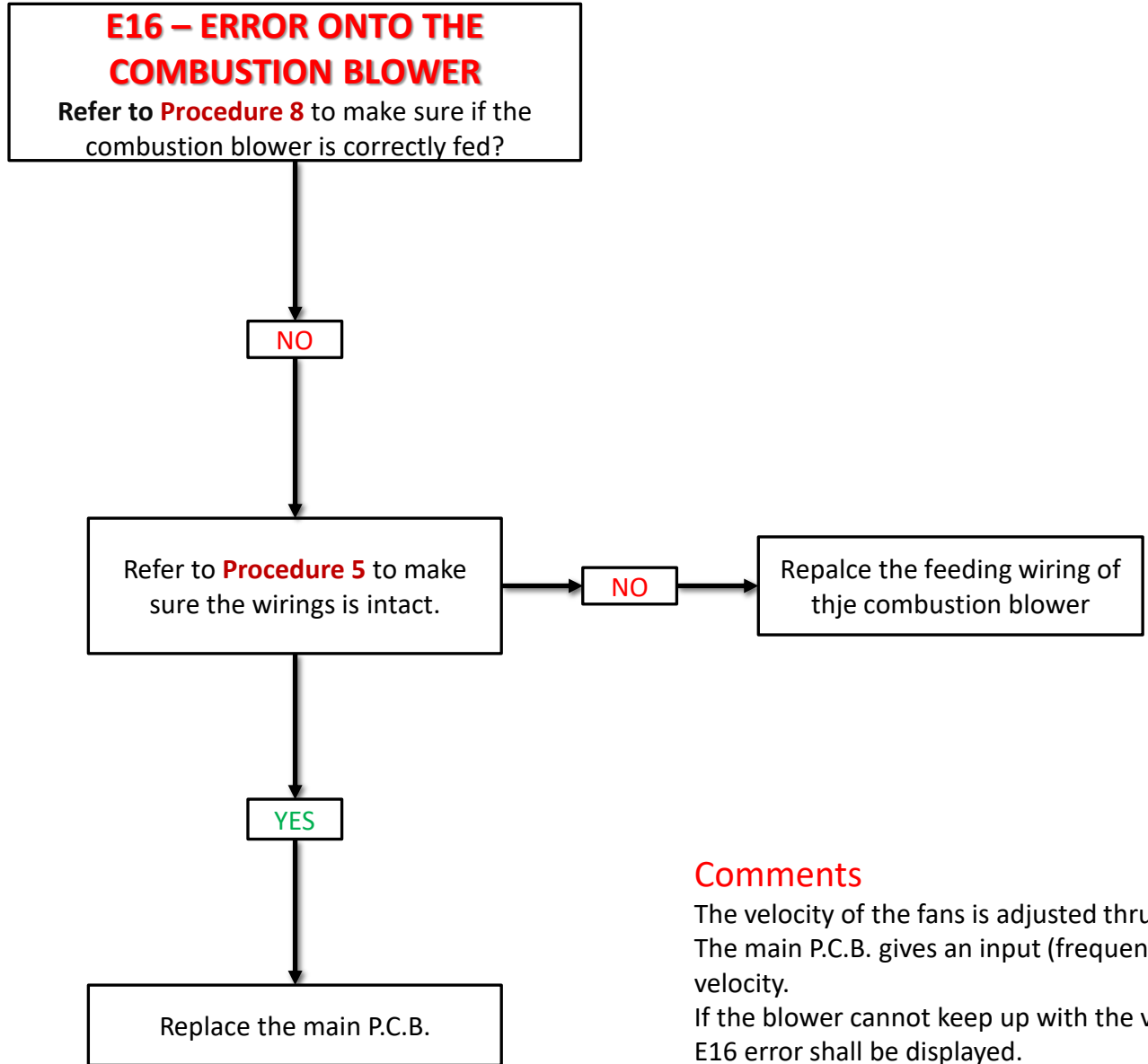

Comments

The velocity of the fans is adjusted thru a frequency modulation.
The main P.C.B. gives an input (frequency) to the blower , that reacts thru the reading of its velocity.
If the blower cannot keep up with the velocity as set thru the P.C.B. for at least 30 seconds, the E16 error shall be displayed.
If the wiring is interrupted or broken, the blower goes at its maximum speed.

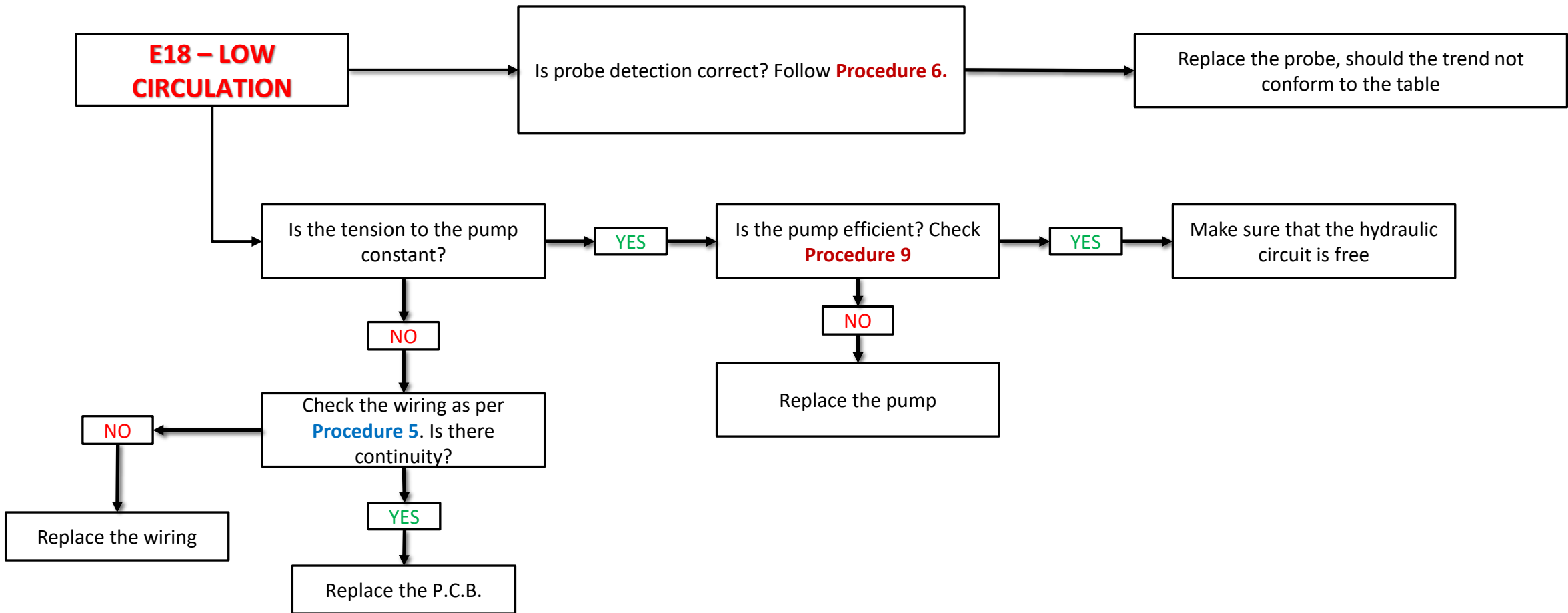

Note

E18 is a circulation error tracked by monitoring the temperature change detected by the flow probe.

If the flow temperature does not increase or decrease by at least 1°C in the 10 seconds following the flame detection, a cooling time of 2 minutes starts. Fan and pump operate and E18 is shown on the display, which cannot be reset. A new ignition attempt (like the first one) follows and if the anomaly recurs, another cooling time is started. At the end of the second cooling time pump and fan are stopped and error E18 can be reset.

The check will not start if there is no flame detection; in this case error E01 - ignition lock will be a priority.

The check is carried out only in case of a new request for operation. Once successfully passed, it is no longer carried out until the next request.

A request ends when post-circulation has also ended.

It is possible to disable this check by setting P35 = 0. The check is enabled by default (P35 = 1).

E19 – FLOW SWITCH

Thru parameter P72 set @1, you can activate the reading of a free contact to display the activation of a water flow switch, fitted onto the product inlet.

The water flow switch has to be connected onto contact M12, pins 42-43 of the slave P.C.B.

The contact has to be “normally open”.

The operational scheme is as follows:

Upon the demand, the circulating pumps are stopped for 5 seconds, so the water circulation, thus the P.C.B. can check the contact is open.

If the contact is closed within these 5 seconds, the error E56 is displayed (to avoid the contact is bridged, thus skipped the external safety).

If the contact is open during these 5 seconds, the P.C.B. feed the circulating pumps, to make sure the contact is closed (enough water circulation).

If the contact is not closed within 20 seconds, error E19 is displayed onto the slave P.C.B.

If the contact is closed while the error E19 is still displayed, the boiler runs with no problems and the error is eliminated from the display of the master P.C.B.

If the error E19 is not solved by 2 minutes, the error can be re-set manually, and the units go locked-out permanently.

The pumps won't do the post-circulation and then they would stop.

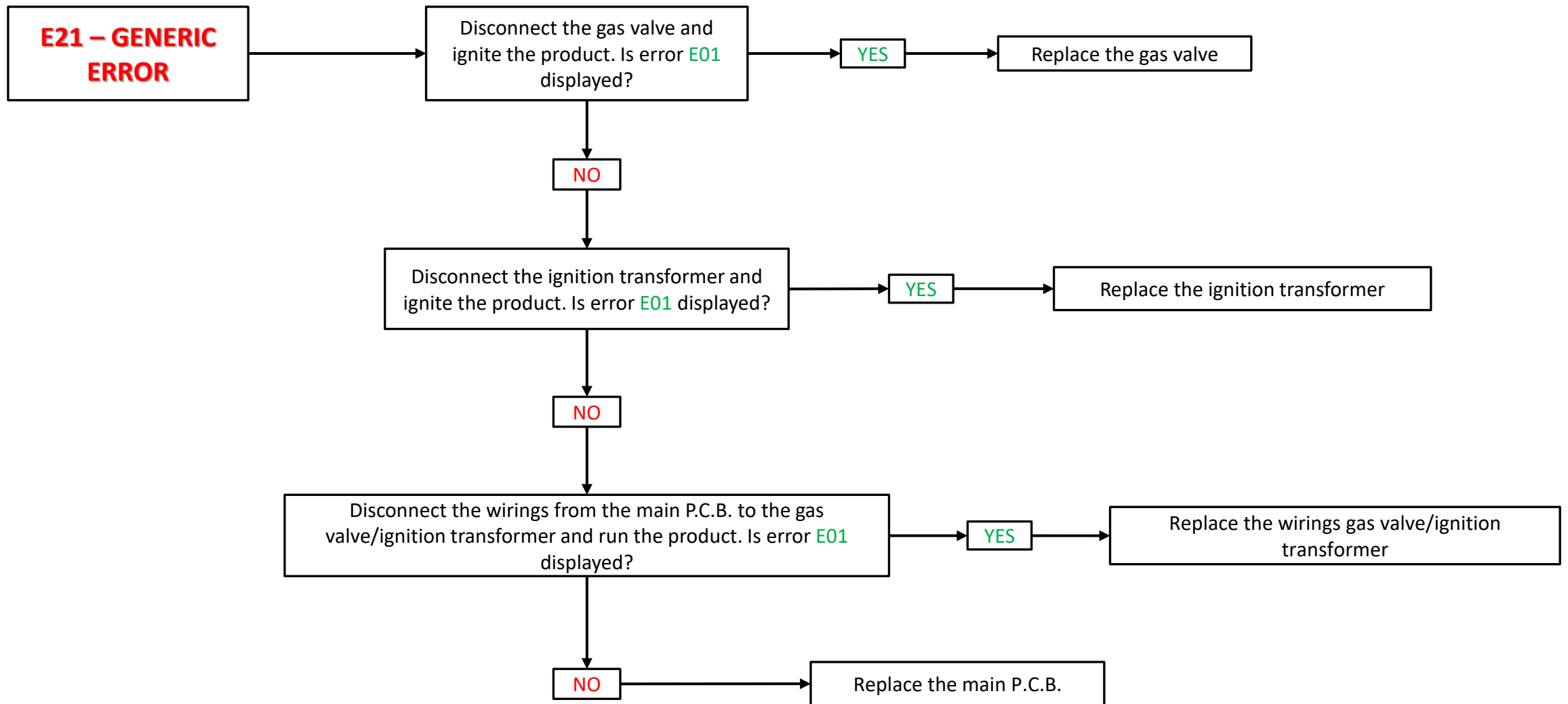

Note

The error E21 is displayed during the ignition cycle and only in a few cases the issue is due to the main P.C.B.
 The display of error E01 during these tests is correct, because the burner won't be ignited when those components are disconnected.

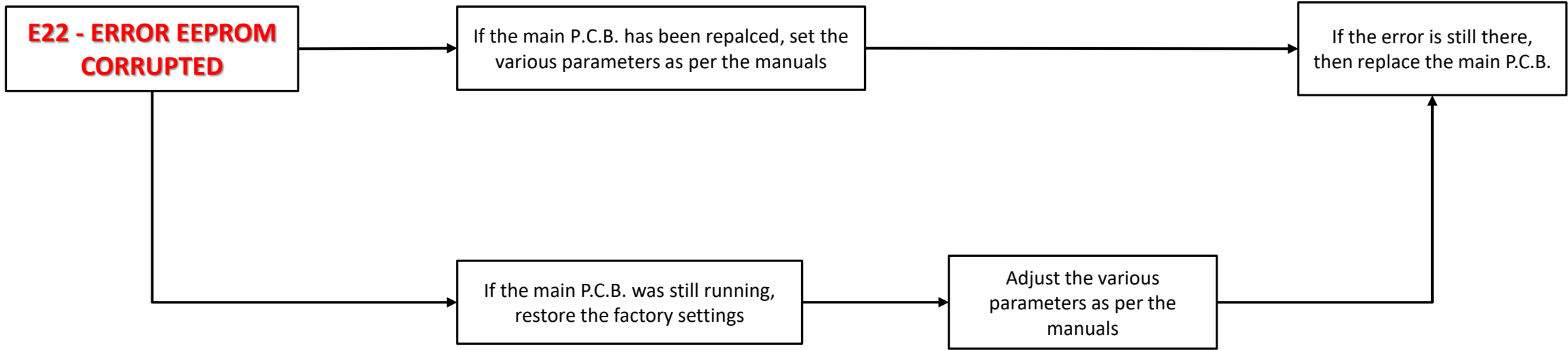

How to restore the factory settings

This is possible by pressing at the same time the buttons «ACS» and «INFO» for 5 seconds. The following icons shall be displayed : Reset; Little Man, plus the capitals «SdF».

**E32 - TIME-OUT COMMUNICATION
BETWEEN THE MAIN P.C.B. AND
THE MODBUS P.C.B.**

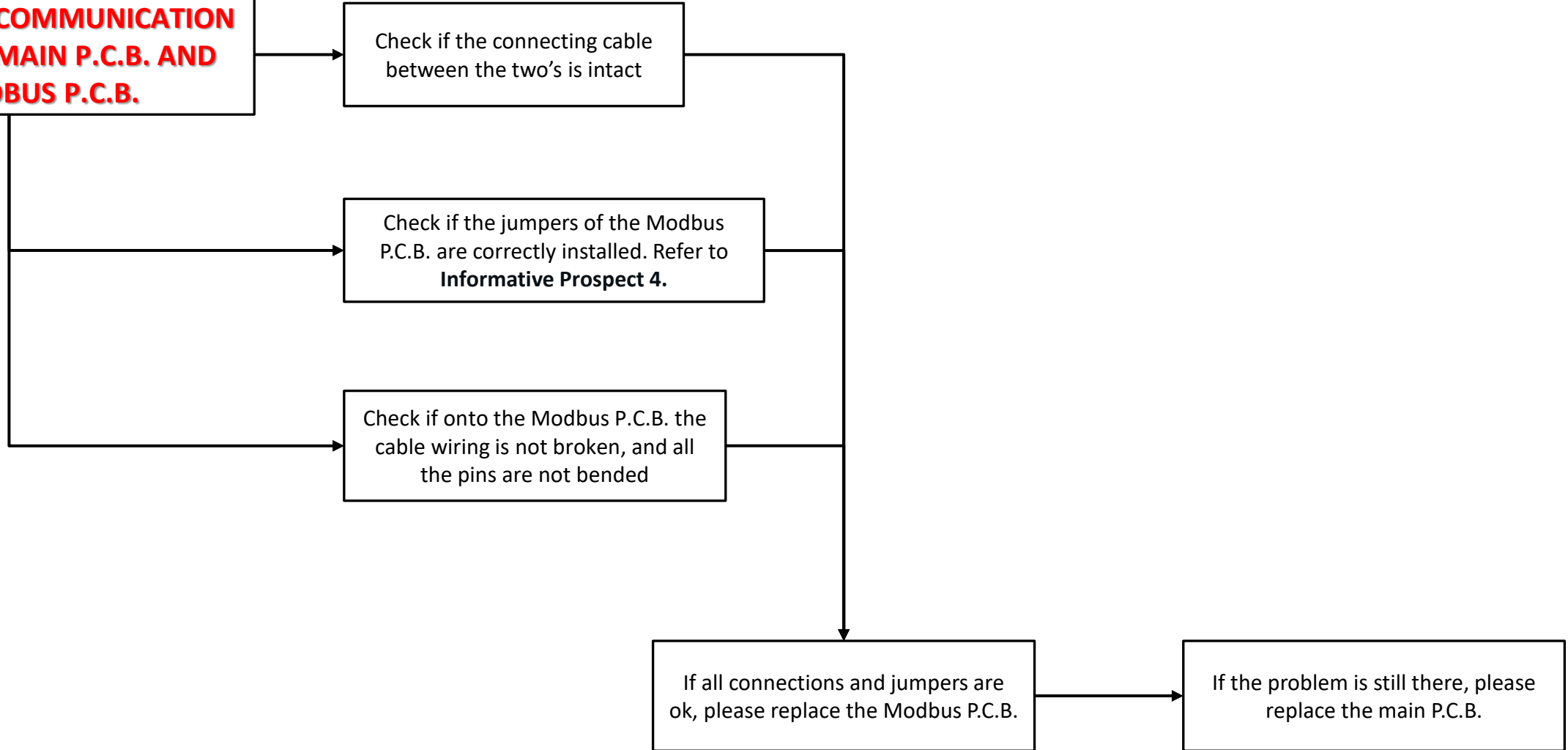

Note

If the Modbus P.C.B. is not installed, the parameter P28 has to be set @ 0

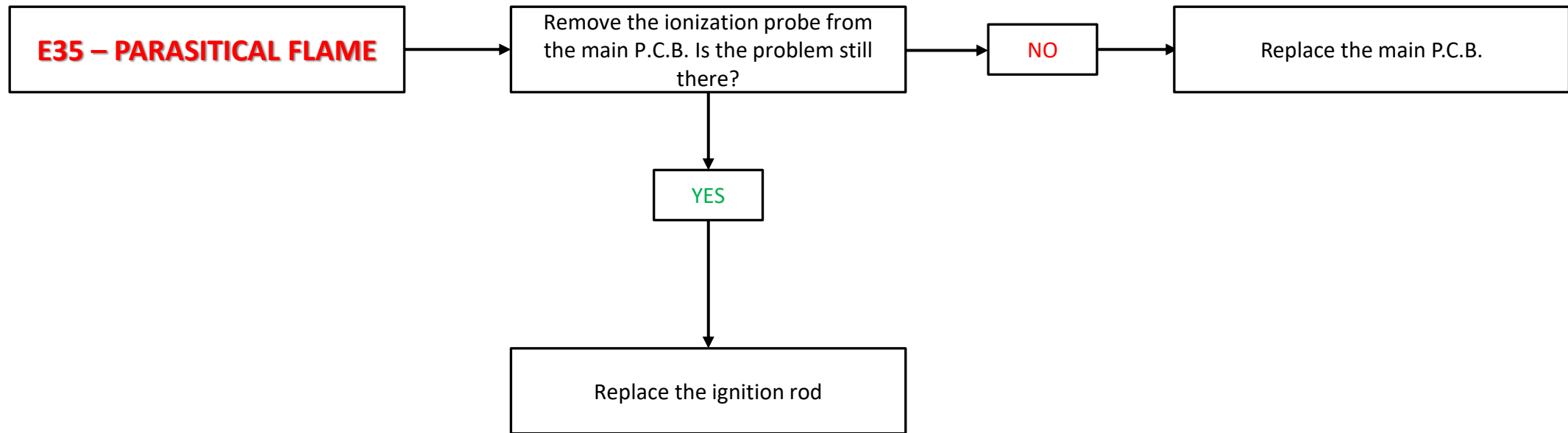

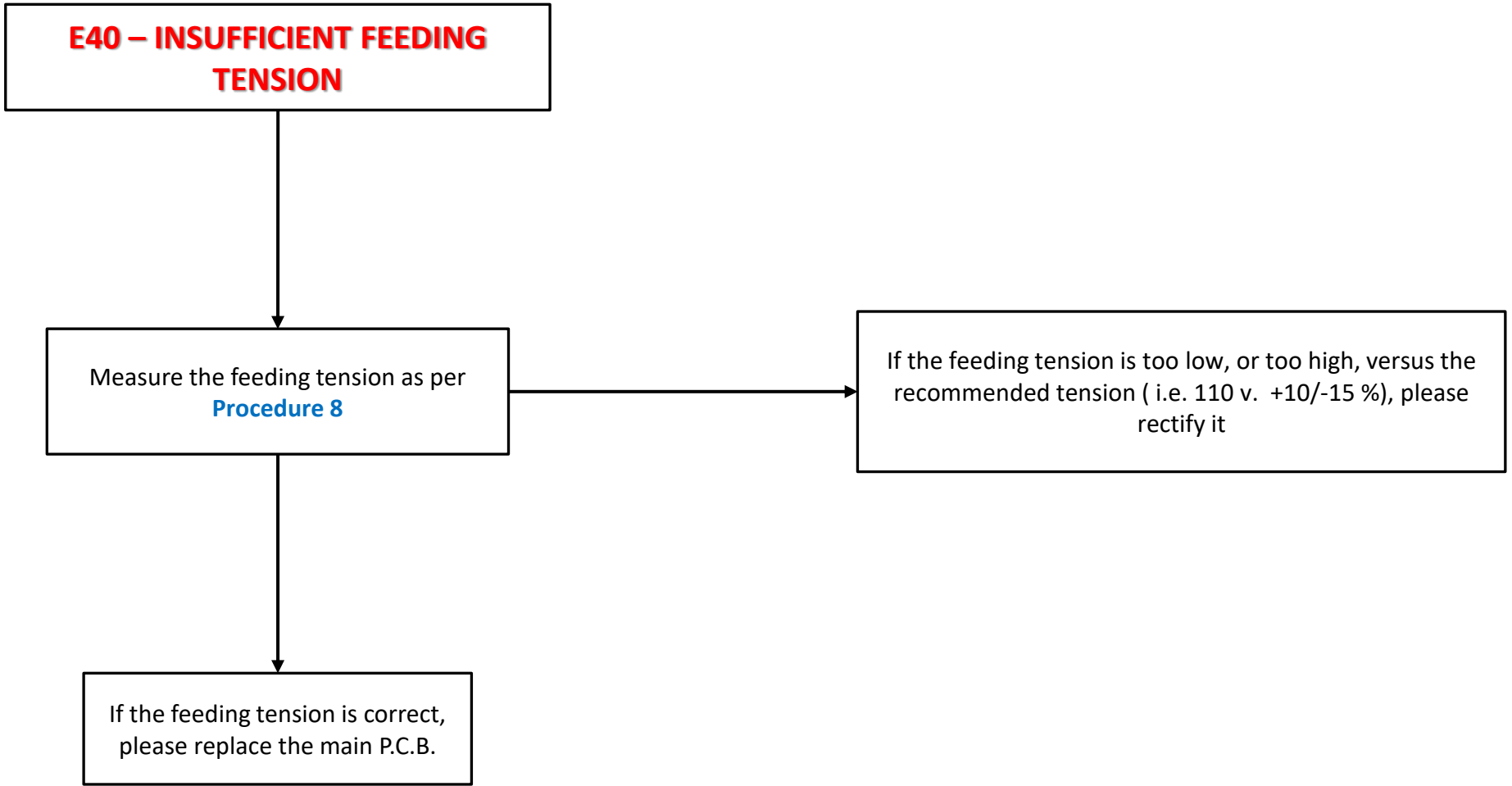

**E52 TIME-OUT COMMUNICATION
BETWEEN THE PRODUCT AND THE
CASCADE CONTROLLER**

As per the **Informative Prospect 3**, check if the connection between the Modbus P.C.B. and the cascade controller is correct.

Re-start together all the units and the cascade controller, then wait for 2 minutes to have the whole arrangement synchronized

Check if the feeding (24 v.) of the controller is kept within a range of ± 10 % and AC.

If the problem is still there, replace the cascade controller

If the connections and the jumpers are ok, i replace the interface P.C.B. of the Modbus

Note

If the Modbus P.C.B. is not installed, the parameter P28 has to be set @ 0

E56 – FLOW SWITCH

E56 error is displayed when the contact of the flow-switch is closed.

Has the contact of the flow switch been bridged?

Check the contacts of the flow switch by means of multi meter

Thru parameter P72 set @1, you can activate the reading of a free contact to display the activation of a water flow switch, fitted onto the product inlet.

The water flow switch has to be connected onto contact M12, pins 42-43 of the slave P.C.B.

The contact has to be “normally open”.

The operational scheme is as follows:

Upon the demand, the circulating pumps are stopped for 5 seconds, so the water circulation, thus the P.C.B. can check the contact is open.

If the contact is closed within these 5 seconds, the error E56 is displayed (to avoid the contact is bridged, thus skipped the external safety).

If the contact is open during these 5 seconds, the P.C.B. feed the circulating pumps, to make sure the contact is closed (enough water circulation).

If the contact is not closed within 20 seconds, error E19 is displayed onto the slave P.C.B.

If the contact is closed while the error E19 is still displayed, the boiler runs with no problems and the error is eliminated from the display of the master P.C.B.

If the error E19 is not solved by 2 minutes, the error can be re-set manually, and the units go locked-out permanently.

The pumps won't do the post-circulation and then they would stop.

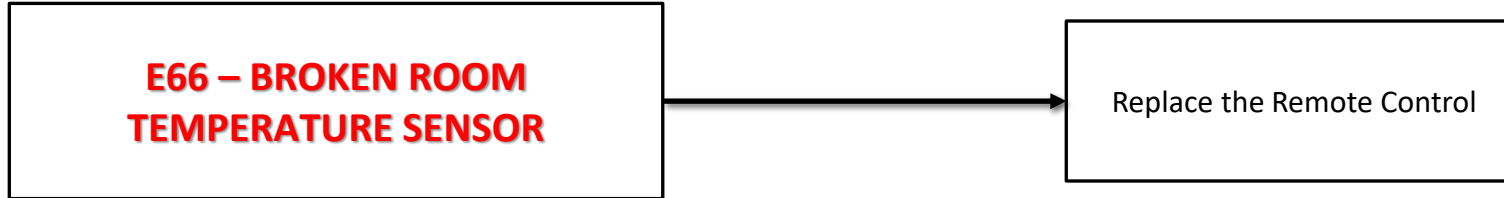

Note

The error of the Remote Control is not displayed onto the product.

**ACCESSORIES (DO WE
NEED THIS??)**

Accessory 1 – Flow-meter kit for MIAH P.C.B.'s (check compatibility according to the model), code 65-00712:

This accessory allows water flow rate measurement in the circuit in which it is inserted. The Huba Control flow-meter works by using Kàrmàn vortex streets: thanks to this innovative method, the mechanical parts inside the component are avoided (there is no classic "propeller"). Having no moving parts means avoiding appreciable pressure losses since the available passage for water is the whole internal section of the flow-meter. Furthermore, there will be no impellers subject to breakage due to dirt or water hammer.

- Parameter 32 to enable (value 1) or disable (value 0) the flow-meter reading;
- Parameter 33 to set the minimum flow rate, below which the boiler gets blocked, showing error E10

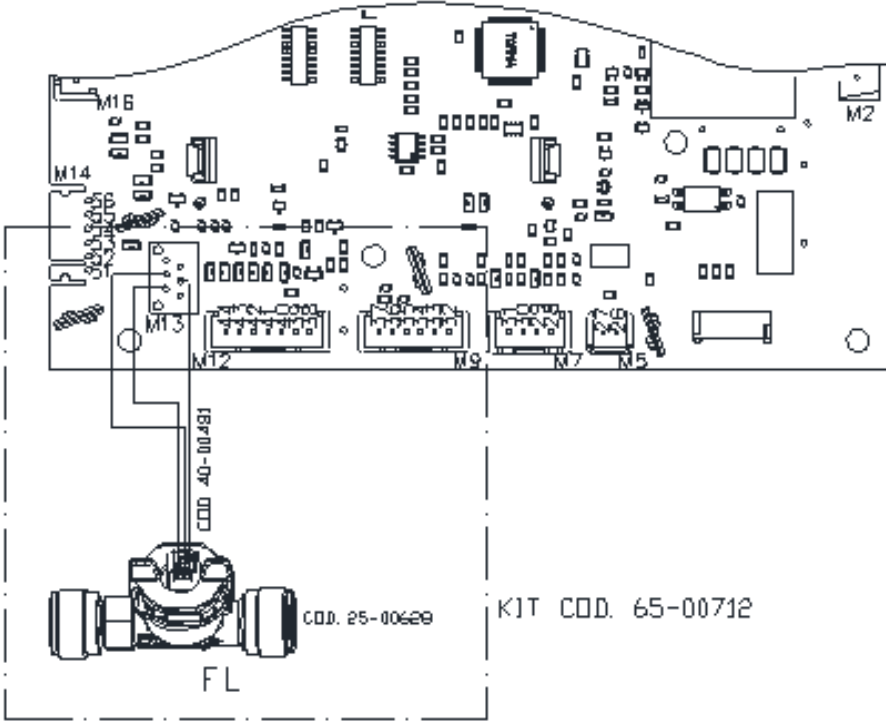

Lt./min	cFlwDHW
3	17
4	23
5	28
6	34
7	39
8	44
9	50
10	55
11	61
12	66
13	72
14	77
15	82

Up to 50 lt/minute, that is 272 Hz

Accessory 2 – Multi zones kit, code 65-00030:

This accessory allows multiple heating zones management. The zones are controlled by classic thermostats with clean contact (open / closed without voltage) and one zone with a Radiant remote control.

HEATING REQUEST FROM THE REMOTE ZONE

The remote control starts the boiler in heating mode; the boiler opens the remote zone valve through contact 2 of the SVZ P.C.B.

HEATING REQUEST FROM ANY THERMOSTAT

Any thermostat opens its own zone valve; the limit switch of this zone valve starts the boiler through the CLEAN contact 8-9.

Auxiliary contact to insert a possible indicator light for boiler block

ZONE VALVE POWER SUPPLY OR BOOSTER PUMP WHERE THE REMOTE CONTROL IS INSTALLED

Remote control connection

The remote control will be connected to the TA input in the boiler terminal block. The jumper must be removed and nothing else must be connected to this contact. The TA input supports only one Open Therm communication. This port cannot be used to connect multiple remote controls.

ZONE VALVES CLEAN CONTACT

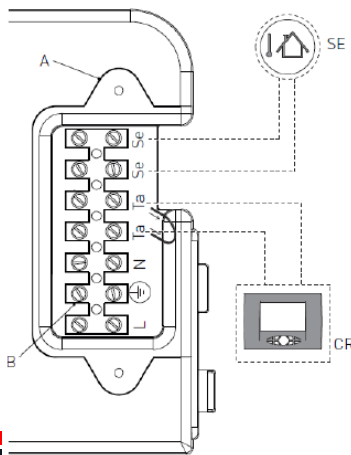
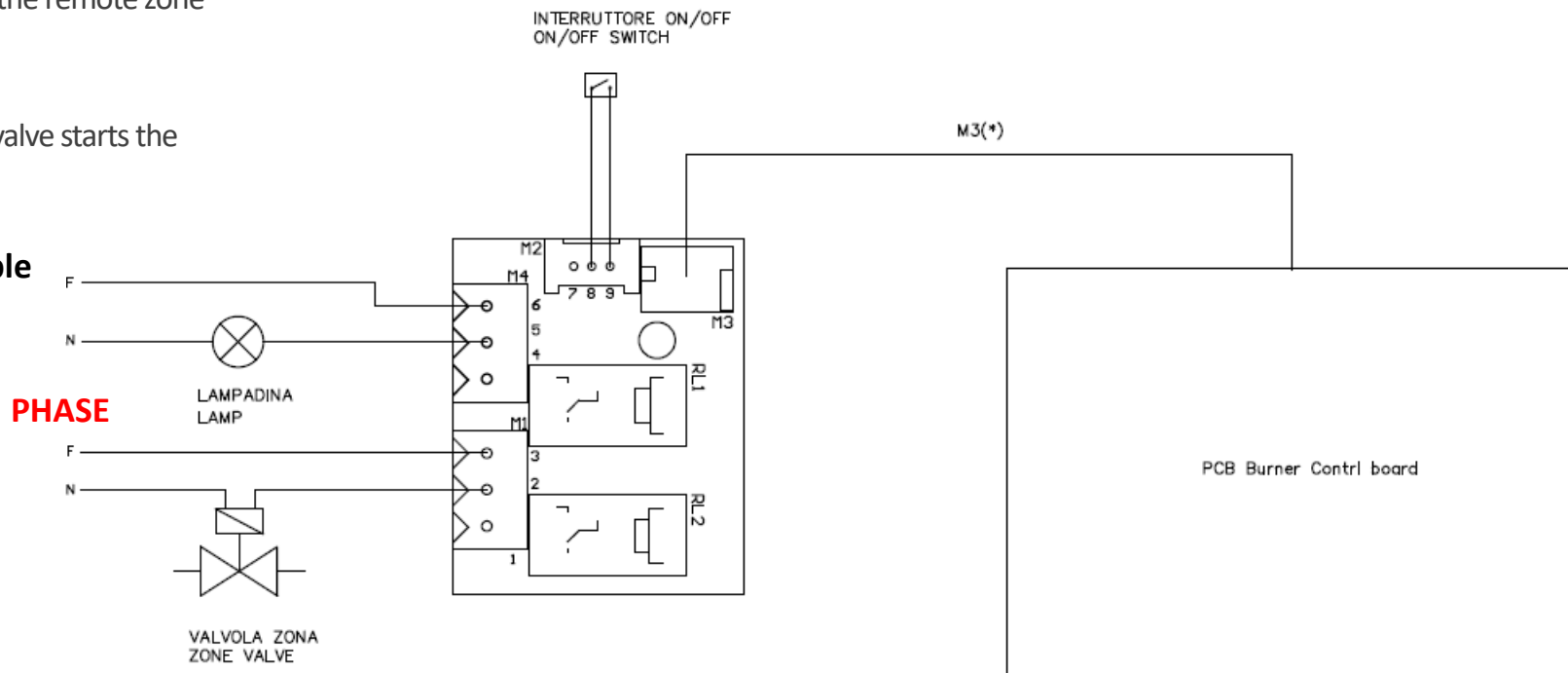

Accessory 2 – Multi zones kit, code 65-00030

Relay functioning

RL1 and RL2 are double acting relays; contacts 4 and 1 are normally closed.

The above diagram shows the classic connection to a remote indicator light to signal the block of the unit (RL1) and a zone valve with automatic return powered by a request of the remote control (RL2).

A phase can be connected to pin 4 of RL1 to signal that everything is fine.

A phase can be connected to pin 1 of RL2 to close the remote control zone valve at the end of the heat request.

Booster pumps management

In case of a multi zones system managed with booster pumps, the remote pump can be managed directly from the zone P.C.B. provided that the absorption remains within the values stated below.

As an example, a classic pump installed on traditional boilers in the last 20/30 years has an electrical absorption of about 80/120 watts and power currents of about 0.40/0.60 Ampere.

Maximum current	3A at 250VAC, 5A at 30VDC
Maximum voltage	277VAC, 30VDC

PROCEDURES AS FOR THE VARIOUS DIAGNOSTICS

Procedure 1 – Control of the dynamic and static pressure

Proceed as follows to check the gas static pressure onto the product:

- Turn off the product;
- Insert a manometer onto the gas inlet and turn on the product;
- What you read is actually the static pressure, because the product is not running.

Ignite the product at its maximum fire power. The inlet gas pressure goes down and this is the dynamic pressure to read. Make sure this pressure is enough to let the product running conveniently, as per the related technical manuals.

The gas pressure drop is understandable, and it depends on the resistance throughout the gas pipings.

The resistance becomes higher and higher onto the joints, bends, small sections, or long lengths.

When the gas pressure drop is too much, this might lead to these inconveniences:

- On/off of the burner;
- Bad combustion and noise;
- Lesser efficiency and the nominal fire power hard to achieve.

Static pressure



Dynamic pressure

Procedure 2 – Control of the opening of the gas valve

Please proceed as follows:

- Turn off the product and insert the manometer onto the gas valve inlet: the manometer shall show the gas pressure of the network;
- Close the gas tap located on the bottom of the product and ignite the burner;
- If the gas valve opens, the pressure of the manometer goes rapidly to zero , or even to a negative value, because the blower sucks from the gas valve vene if there is no gas indeed;
- If the gas valve does not open, the gas pressure stays the same during the ignition.

Static pressure



Procedure 3 – Control of the Sit 848 gas valve coils - 230 v.

Set the tester as per the attached pic, and then measure the resistances of coils EV1 and EV2.

These are the right values:

- Ev1 1560 Ohm between 3 and 4
- Ev2 6530 Ohm between 3 and 1

Small deviations from the above values are still acceptable.

Modulator:

The pneumatic modulator varies according to the RPM of the blower.

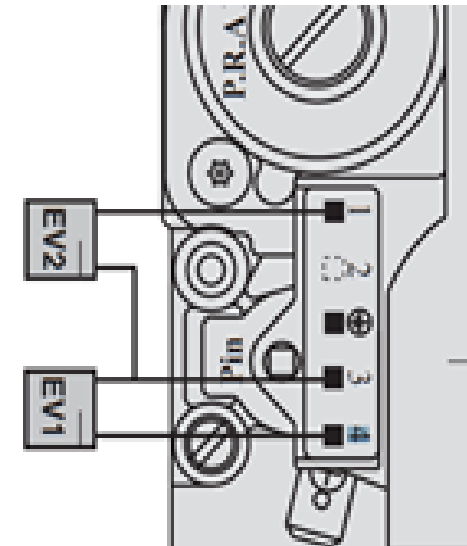
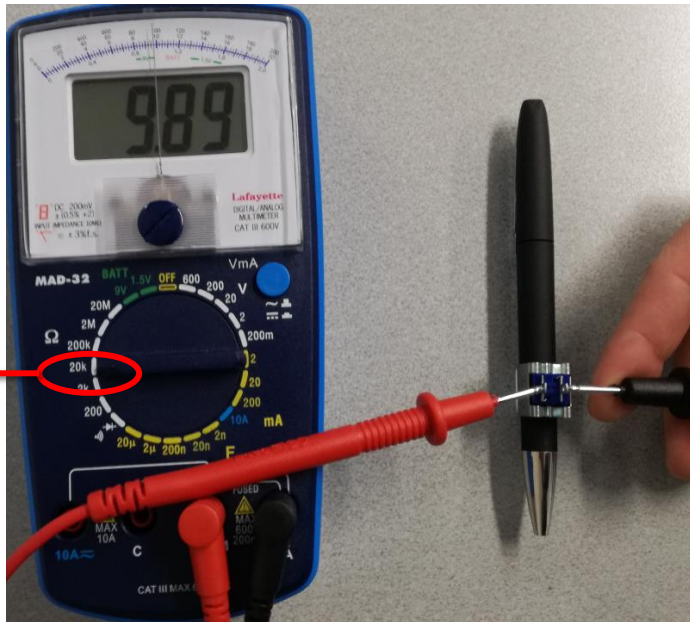

Procedure 4 – Measure of the ionization current

- Set the tested as μA (micro Ampere);
- Connect the pins in parallel between the ionization electrode and the P.C.B. connection;
- Make sure the ionization current is higher than $5 \mu\text{A}$

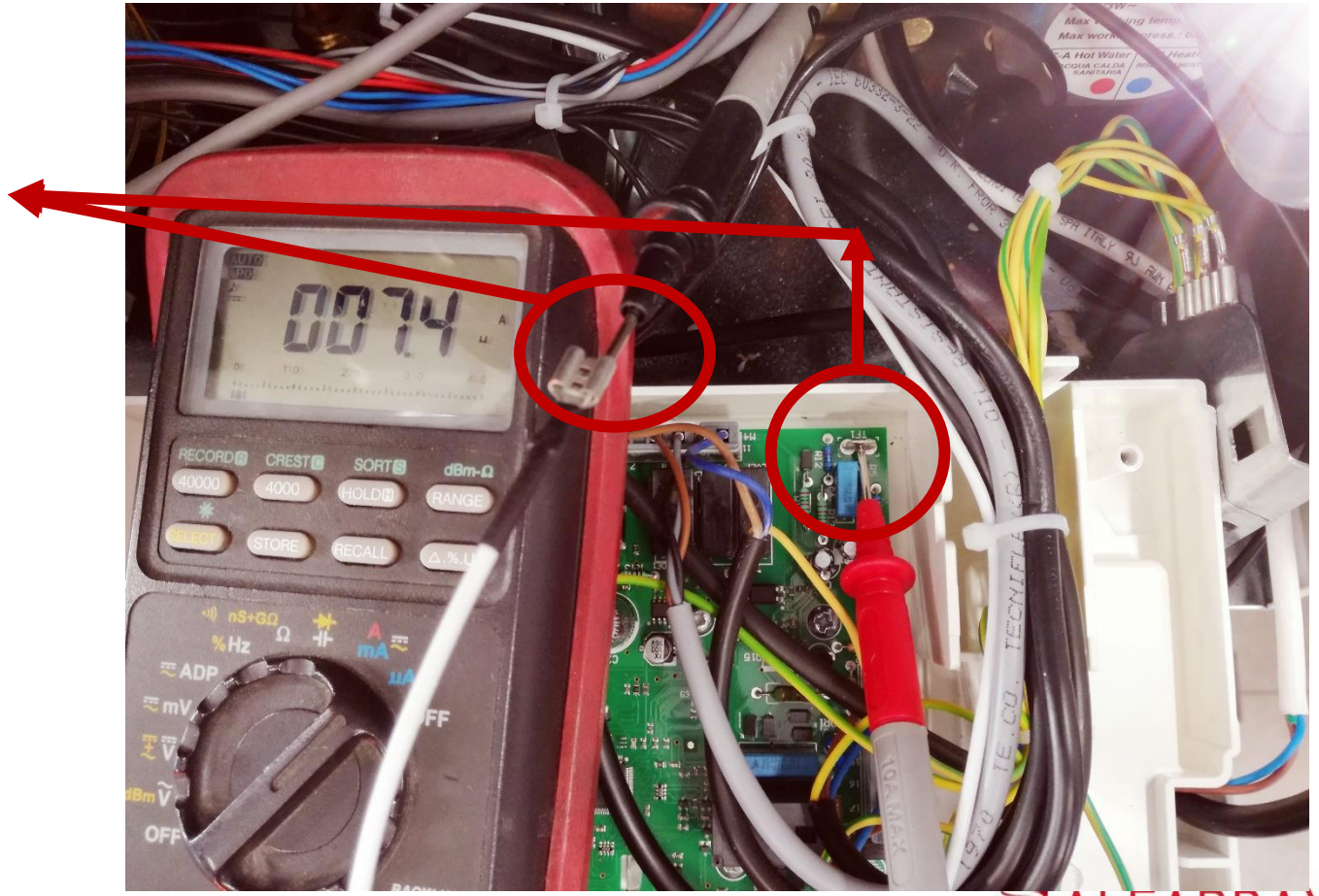

Procedure 5 – Continuity control

Thru a tester, it is possible to verify if an electrical circuit is interrupted:

- Position the Tester onto the «Diodo» symbol;
- Position the pins of the Tester at the edges of the circuit to verify;

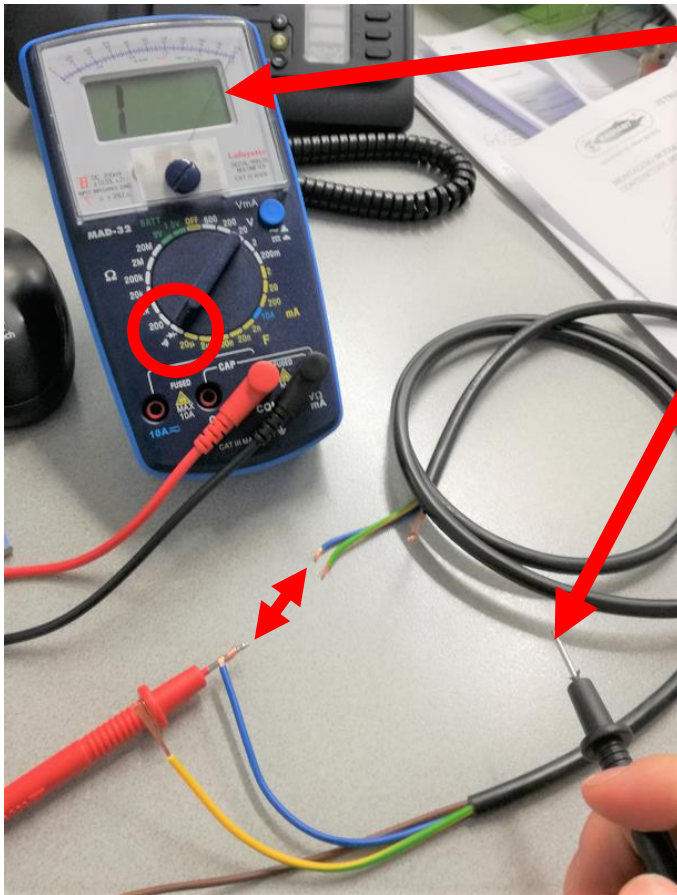

Open circuit

Sealed circuit

Note

These testers might produce a beep, if the circuit is sealed.

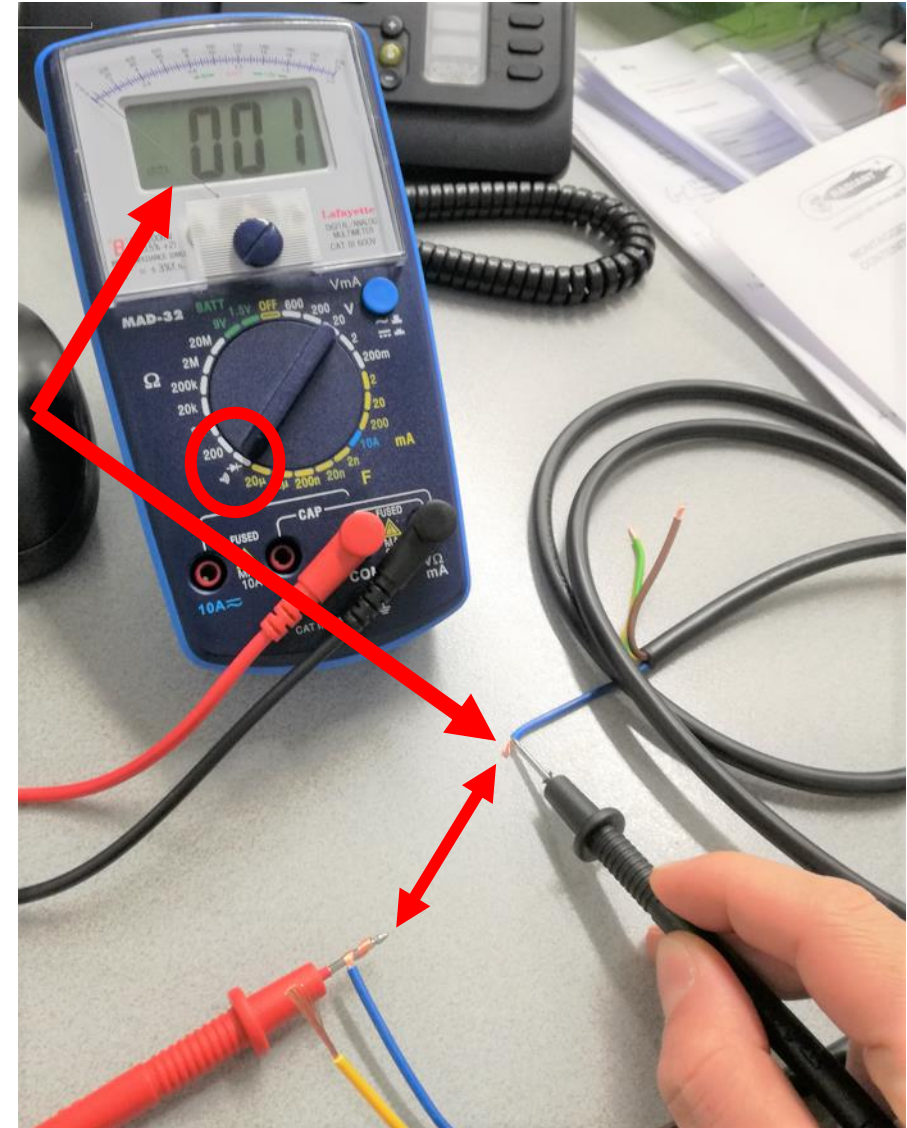

Procedure 6 – Control of the resistances

Each individual sensor has its resistance value, that varies as per the temperature. Thru the tester it is possible to verify if the sensors are ok:

- Position the Tester at Ω (Ohm), the full-scale has to be higher than the value to be measured;
- Position the pins of the Tester to the edges of the component to be verified;

All the Radiant sensors bear the values as per the attached table.

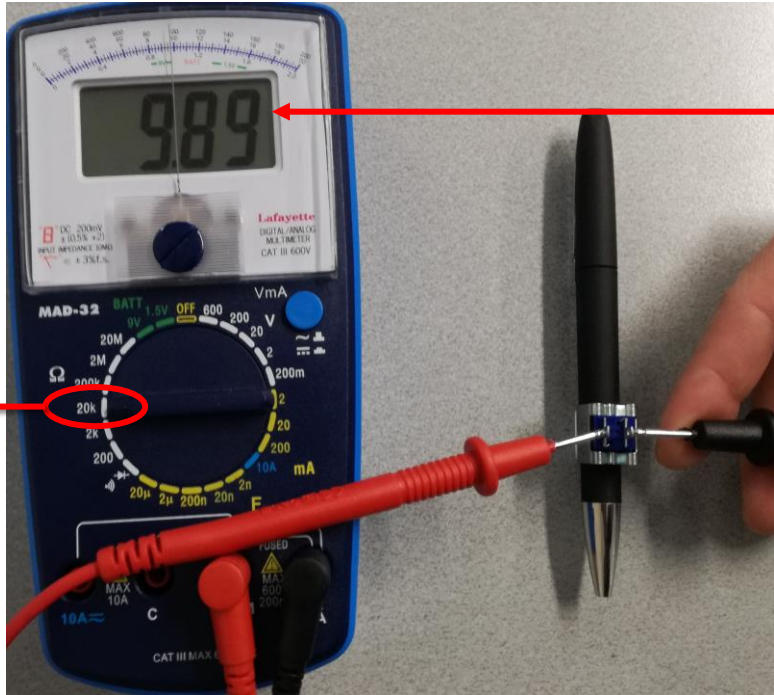

Temp	R NTC	Temp	R NTC	Temp	R NTC	Temp	R NTC	Temp	R NTC
-50	329200	-15	53432	20	12090	55	3538	90	1266
-49	310868	-14	51018	21	11634	56	3426	91	1232
-48	293656	-13	48707	22	11199	57	3319	92	1199
-47	277489	-12	46513	23	10781	58	3216	93	1168
-46	262299	-11	44429	24	10382	59	3115	94	1137
-45	248023	-10	42449	25	9999	60	3021	95	1109
-44	234600	-9	40568	26	9633	61	2928	96	1079
-43	221976	-8	38780	27	9281	62	2839	97	1051
-42	210099	-7	37079	28	8945	63	2753	98	1024
-41	198922	-6	35463	29	8622	64	2669	99	998
-40	188399	-5	33925	30	8313	65	2589	100	973
-39	178490	-4	32461	31	8016	66	2512	101	948
-38	169156	-3	31069	32	7731	67	2437	102	925
-37	160359	-2	29743	33	7458	68	2365	103	901
-36	152068	-1	28481	34	7196	69	2292	104	879
-35	144250	0	27279	35	6944	70	2229	105	857
-34	136876	1	26136	36	6702	71	2164	106	836
-33	129912	2	25044	37	6470	72	2101	107	815
-32	123353	3	24004	38	6247	73	2040	108	796
-31	117154	4	23014	39	6033	74	1982	109	776
-30	111299	5	22069	40	5828	75	1925	110	757
-29	105769	6	21168	41	5630	76	1870		
-28	100544	7	20309	42	5440	77	1817		
-27	95605	8	19489	43	5258	78	1766		
-26	90934	9	18706	44	5082	79	1717		
-25	86518	10	17959	45	4933	80	1669		
-24	82339	11	17245	46	4751	81	1622		
-23	78384	12	16563	47	4590	82	1577		
-22	74641	13	15912	48	4444	83	1534		
-21	71097	14	15289	49	4300	84	1491		
-20	67739	15	14694	50	4161	85	1451		
-19	64571	16	14126	51	4026	86	1411		
-18	61563	17	13582	52	3897	87	1373		
-17	58719	18	13062	53	3773	88	1336		
-16	56016	19	12565	54	3653	89	1300		

Procedure 6 – Control of the resistances

Each individual sensor has its resistance value, that varies as per the temperature. Thru the tester it is possible to verify if the sensors are ok:

- Position the Tester at Ω (Ohm), the full-scale has to be higher than the value to be measured;
- Position the pins of the Tester to the edges of the component to be verified;

All the Radiant sensors bear the values as per the attached table

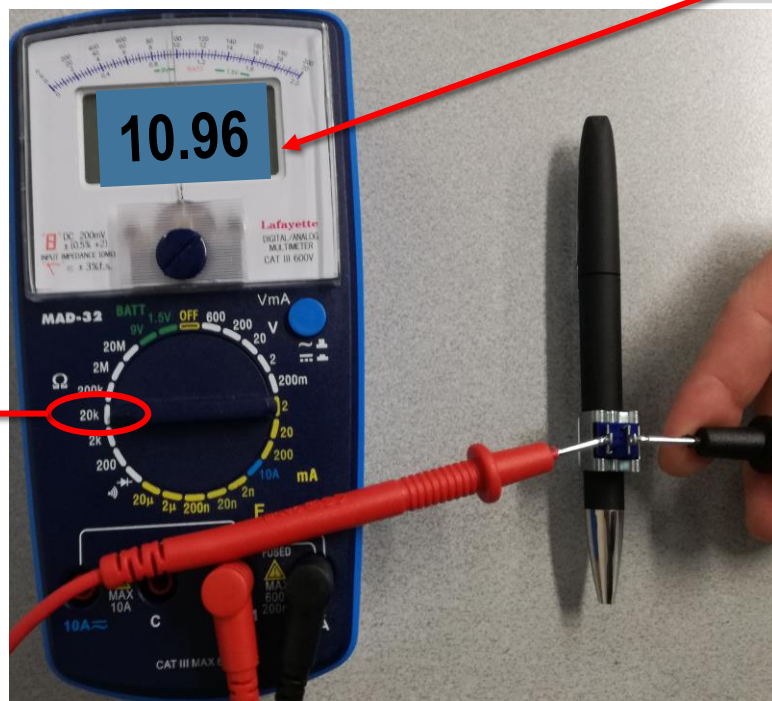

PT1000 – VF1000 – SPF1000 – KLF1000

Valori della sonda

Temp. [°C]	Pt 1000 VF1000, SPF1000, KLF1000 [Ω]
-30	882
-25	901
-20	921
-15	941
-10	960
-5	980
0	1000
5	1019
10	1039
15	1058
20	1077
25	1097
30	1116
35	1136
40	1155
45	1174
50	1194
55	1213
60	1232
65	1251
70	1270
75	1289
80	1309
85	1328
90	1347
95	1366
100	1385
105	1404
110	1422
115	1441
120	1460
125	1479
130	1498

Temp. [°C]	Pt 1000 VF1000, SPF1000, KLF1000 [Ω]
135	1517
140	1535
145	1554
150	1573
155	1591
160	1610
165	1629
170	1647
175	1666
180	1684
185	1703
190	1721
195	1740
200	1758
205	1776
210	1795
215	1813
220	1831
225	1850
230	1868
235	1886
240	1904
245	1922
250	1941

Procedure 7 – Air/gas mixture flammability

To get it a combustion started, there must be a proper contribution of gas and air.

The sparks are not just enough: the amount of gas has to be right.

If the gas valve actually opens, but there is no ignition (as per **Procedure 2**), we would recommend these simple steps are arranged:

- Turn off the product;
- Close partially the fresh air inlet of the combustion blower by means of a hand;
- Ignite the product and, upon the start f the ignition cycle, remove slowly the hand until the burner fires-up.

If the burner does not ignite after a number of tries, there is probably too much gas that has to reduced until the burner ignites.

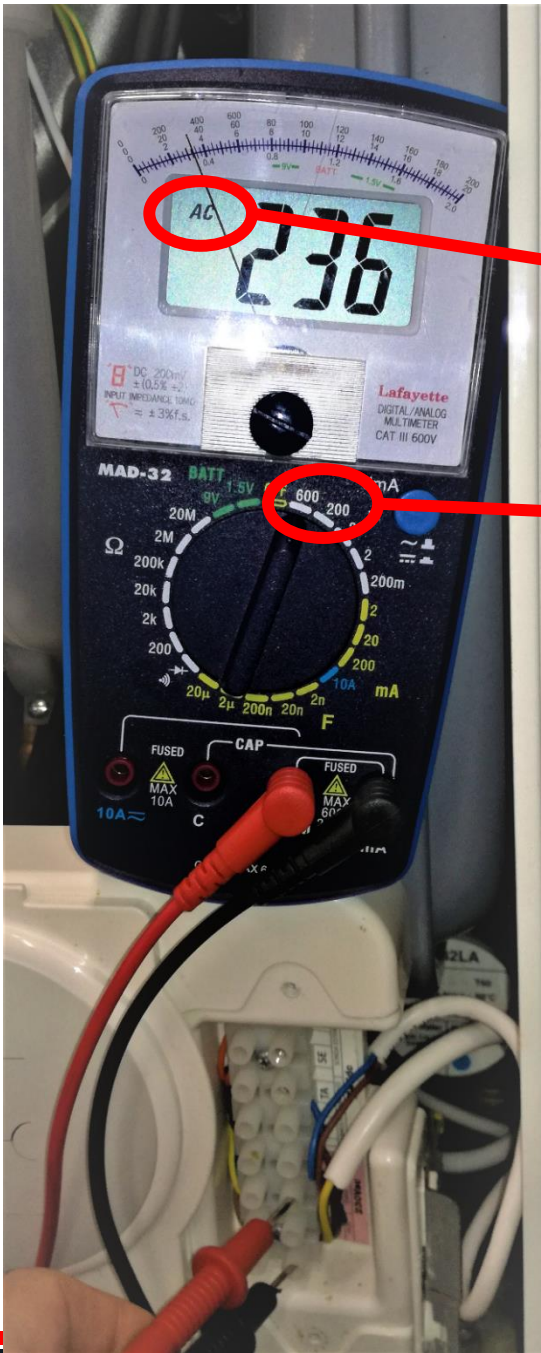

Procedure 8 – Measurement of a tension

- Turn on the Tester into the mode « Measure of the tension » (V = Volt) and choose if the tension to be detected is Continuous (–) or Alternate (~);
- Choose the full-scope according to the measure (this pic shows 600 and not 200, because we were to measure a value higher than 200 but less than 600);
If we were to measure a tension of 120 v., we were to pick 200 v.
- Touch the tension spots thru the pins of the Tester.

Procedure 9 – Control of the circulating pump efficiency

An easy and quick way to check the efficiency of the pump is the following:

- Instal a manometer onto the return and another one onto the inlet (heating loop), so the circulating pump stays between the two manometers;
- Instal a shutter between the INLET manometer and the installation;
- Fill up and flush out the water loop;
- Close the INLET shutter (after the manometer);

Run the pump and read the values of the two manometers. The inlet pressure has to be higher than the return one. The difference shall confirm if the circulating pump runs correctly.

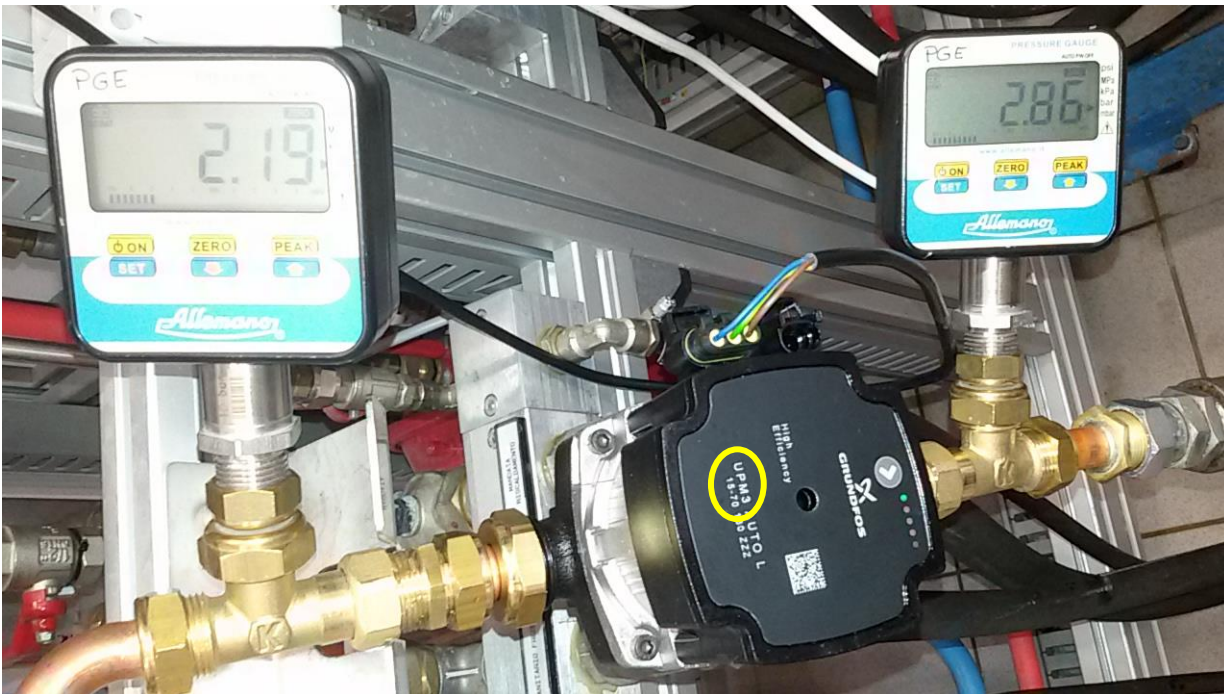

This example shows a difference between the two manometers of 0.67 bars.

1 bar is equal to 10 m. of water column. So there is water column of 6.7 m. The factory value is 7 m. as per the yellow mark, so the difference of just 0.3 m. shows the pump is still pretty efficient.

If for instance, the difference was of 0.44 bar (4.4 m.), the circulating pump was to be replaced.

STANDARD PRESSURE: CONTACT CLOSURES AT 1 bar - CONTACT OPENS AT 0.2 bar - RANGE 0.8 bar

Procedure 10 – Water pressure switch calibration

By adjusting the "A" screw to the minus, the closing pressure is changed.
Every 1/4 of a turn the pressure drops by 0.2 bar.

By adjusting the "B" screw to the minus, the range changes.

By turning the "A" central screw to the minus of 1/4 of a turn and the "B" screw to the minus of 1/2 of a turn, the new calibration is obtained.

See table.

N.B: if you adjust "A" screw it is **MANDATORY** to adjust also "B" screw.

"A" SCREW	"B" SCREW	PRESSURE	
		ON	OFF
- ¼ of a turn	- ½ of a turn	0,8 bar	0,2 bar
- ½ of a turn	- 1 turn	0,6 bar	0,2 bar

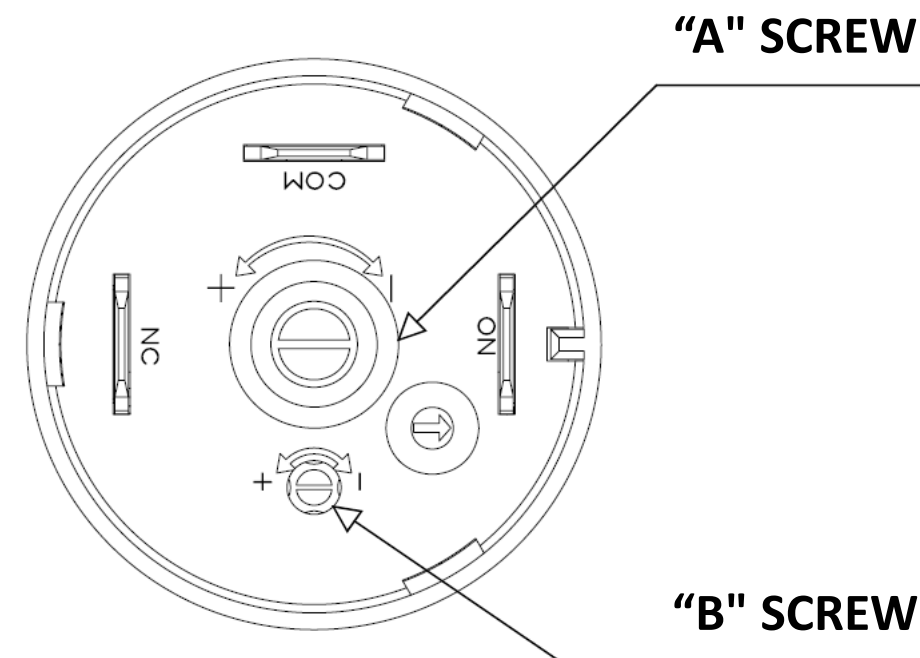
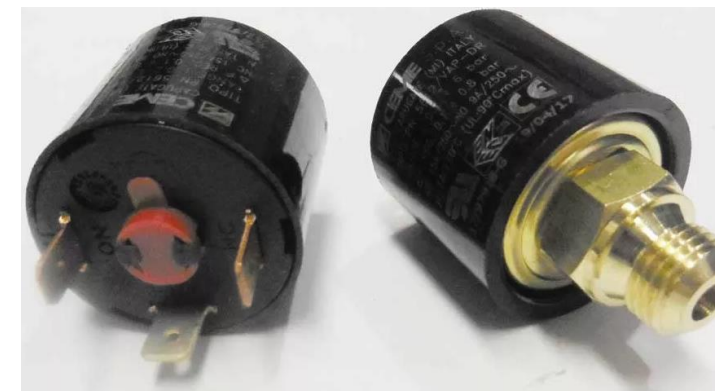

INFORMATIVE PROSPECTS

Informative prospect 1 – High smokes temperature

The smokes temperature can be analysed using a combustion analyser.

For Radiant pre-mixed condensing boilers, a smokes temperature value close to the flow temperature can be considered satisfactory.

	Maximum Power (Flow 80°C / Return 60°C)	Maximum Power (Flow 50°C / Return 30°C)
Smokes temperature	72 °C with coaxial pipe system, 82 °C with twin pipe system	48 °C
CO2	9,6%	9,2%

A very high smokes temperature can be caused by:

- Too much power in the burner;
- Very dirty heat exchanger on the smokes side;
- Very dirty heat exchanger on the water side;
- Deteriorated or broken refractory panels (especially the back ones);

It is also important that the position is correct; in case of problems, it is advisable to replace the fibres by ordering the 65-00538 kit.

This kit includes the refractory fibres shown in the picture (please note the position of the back panel's tab) and the thermofuse.

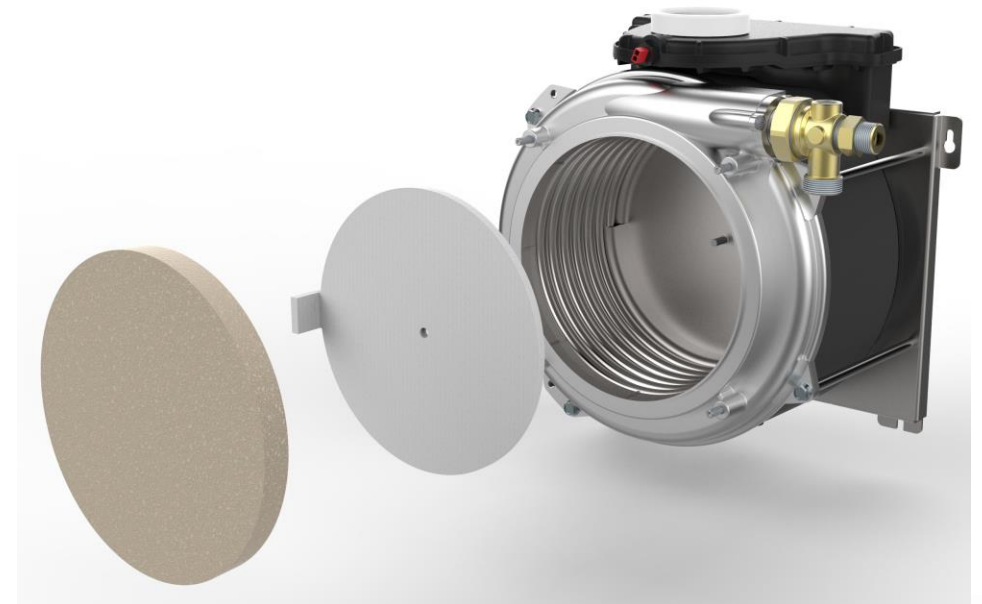

Informative prospect 2 – At what pressure should the heating circuit be charged?

The heating system is a closed circuit: in order to avoid corrosion, circulation and thermal efficiency problems in the system, it is necessary to guarantee a minimum pressure in every point of it.

It is good practice to keep a pressure of at least 0,5 Bar in the highest point of the system, especially if the highest point is an automatic purger.

If a system is 10 mt high, and the boiler is installed in the lowest point of the system, 1,5 Bar will be a «good» pressure value.

1 bar = 10 meters high water column

0,5 bar = minimum pressure in the highest point of the system

In order to avoid to frequently restore the pressure, it is suggested to keep the pre-charge pressure of the expansion vessel slightly lower than the system's operating pressure.

In the above example, if the vessel is charged at 1,4 bar, there will be a small water stock coming out from the vessel to keep the pressure stable longer over time.

Note

It is important to remember that the lower the water pressure in the exchanger, the easier it will boil in the event of problems.

On the contrary, if the water pressure is high, also the boiling point will be higher. This will reduce the risk of breakage of the exchanger in the event of failures that cause the appliance to overheat.

Radiant boilers have no problem in working with pressures of 1 bar and have an upper limit of 3 bar. Safety is guaranteed by a dedicated automatic draining valve. In the case of open vessel systems, it is necessary to evaluate the situation thoroughly and to ensure optimal circulation in heating mode. With the latest versions of the electronics, it is possible to install a flow-meter to ensure good functionality even when the unit is forced to operate with low pressure. See **Accessory 1**

Informative prospect 3 – CORRECT CONNECTION OF MODBUS CIRCUIT

In order to avoid communication problems, the power supply must be 24 Vac \pm 10 %; the connection cables between the cascade controller and the ModBus interface boards must be shielded and the shielding must be connected to the grounding system.

The cascade controller can manage up to 8 Modbus interface boards; the below connection shall be extended to all the Modbus interface boards included in the cascade installation.

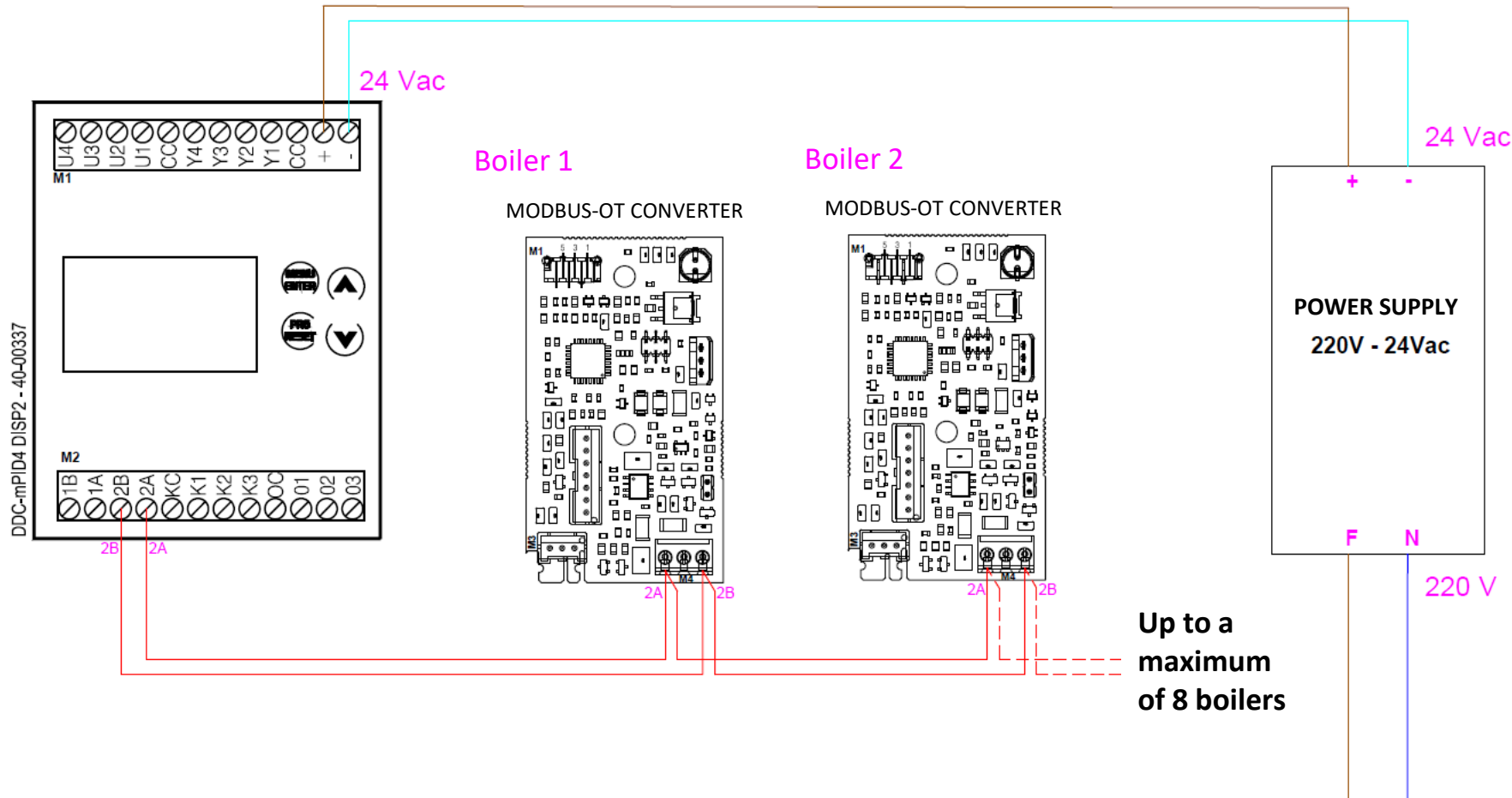

Informative prospect 4 – Correct positioning of jumpers on OT/ModBus interface board

All boilers installed in cascade must have jumpers on the MASTER interface board as shown in Picture 1

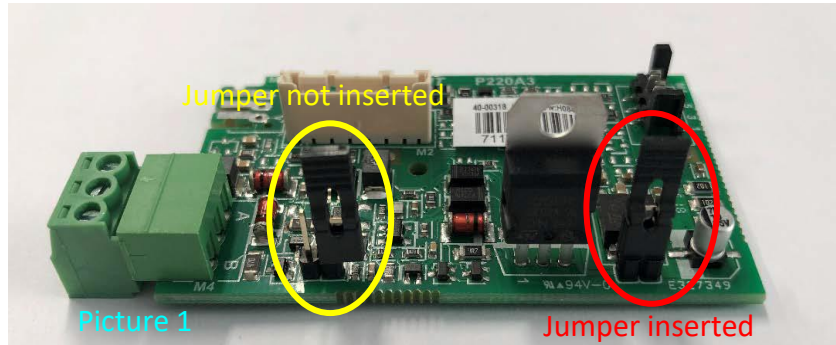

N.B.: For no reason jumpers will have to be placed on the interface board as shown in Pictures 3 and 4

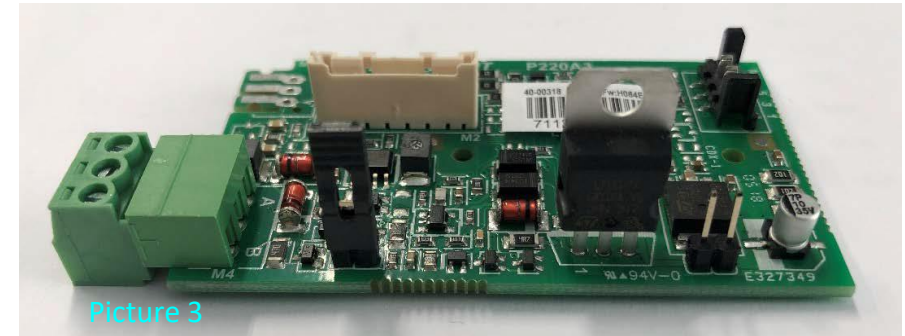

All SLAVE generators of 75 kW and 100 kW boilers with 2 generators must have jumpers on the interface board as shown in Picture 2.

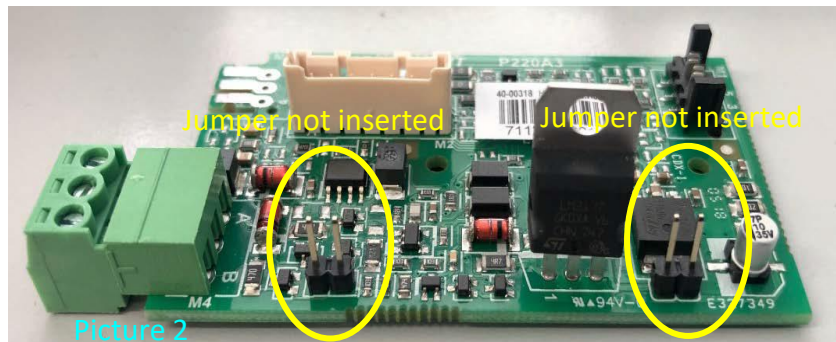

Thank You!

